

*Student
Workbook
for
Discovering
Design with
Biology*

Property of:

Student Workbook for Discovering Design with Biology

Published by
Berean Builders
Muncie, IN
bereanbuilders.com

Copyright ©2022 Berean Builders Publishing, All rights reserved.

Printed in the United States of America

By
My Father's World

ISBN: 978-1-7350291-4-6

A copy of this document can be made for any student who owns Discovering Design with Biology

Table of Contents

Daily Assignments	5
Worksheets	11
Documenting Experiments	101
Laboratory Notebook	103

Daily Assignments

If your school year consists of 180 days, you can use this list of daily assignments to complete the course in one school year.

Week 1:

- Read the introduction and check out the course website
- Read pp. 1-6
- Read pp. 7-9, performing Experiment 1.1 and stopping at Section 1.2
- Read pp. 9-14, stopping at Section 1.4
- Read pp. 14-19, stopping at Section 1.6

Week 2:

- Read pp. 19-22, performing Experiment 1.2 and stopping at Section 1.7
- Read pp. 22-25 and answer questions 1-5 in the Chapter 1 Review
- Answer questions 6-12 in the Chapter 1 Review
- Check your answers for the review and study for the test
- Take the test for Chapter 1

Week 3:

- Read pp. 29-34
- Read pp. 35-37, performing Experiment 2.1 and stopping at Section 2.3
- Read pp. 37-40, performing Experiment 2.2 and stopping at the end of the experiment
- Read pp. 40-44
- Read pp. 45-48, performing Experiment 2.2 and stopping at the end of the experiment

Week 4:

- Read pp. 48-53, stopping after Figure 2.21 is explained
- Read pp. 53-57
- Answer questions in the Chapter 2 Review (You have two days to do this.)
- Finish answering questions in the Chapter 2 Review
- Check your answers for the review and study for the test

Week 5:

- Take the test for Chapter 2
- Read pp. 61-65
- Read pp. 66-68, performing Experiment 3.1 and stopping at Section 3.4
- Read pp. 68-72, stopping after the Comprehension Check questions
- Read pp. 72-74, performing Experiment 3.2 and stopping at Experiment 3.3

Week 6:

- Read pp. 74-76, performing Experiment 3.3 and stopping at Section 3.6
- Read pp. 76-80, stopping at Section 3.8
- Read pp. 80-84
- Read pp. 85-89
- Answer questions in the Chapter 3 Review (You have two days to do this.)

Week 7:

- Finish answering questions in the Chapter 3 Review
- Check your answers for the review and study for the test
- Take the test for Chapter 3
- Read pp. 95-99, stopping at Section 4.3
- Read pp. 99-101, performing Experiment 4.1 and stopping at Section 4.4

Week 8:

- Read pp. 101-105, stopping at Metaphase
- Read pp. 105-109, stopping after the Comprehension Check questions
- Perform Experiment 4.2 and read until Meiosis I on p. 111
- Read pp. 111-116, stopping at Section 4.7
- Read pp. 116-120, stopping at Section 4.8

Week 9:

- Read pp. 120-122 and spend some time reviewing the chapter
- Answer questions in the Chapter 4 Review (You have two days to do this.)
- Finish answering questions in the Chapter 4 Review
- Check your answers for the review and study for the test
- Take the test for Chapter 4

Week 10:

- Read pp. 127-131, stopping after the Comprehension Check questions
- Read pp. 131-133, performing Experiment 5.1 and stopping at the end of the experiment
- Read pp. 133-137, stopping at the beginning of the last paragraph on the page (“To determine...”)
- Read pp. 137-140, performing as much of Experiment 5.2 as you can (It will probably take a few days to collect all the data, since you need to visit some relatives to finish collecting the data.)
- Read pp. 140-145, stopping at Section 5.5

Week 11:

- Read pp. 145-149, stopping at Mutations in a Group of Nucleotides
- Read pp. 149-153, stopping after the Comprehension Check questions
- Read pp. 154-155 and spend some time reviewing the chapter (This is a good time to do the analysis of Experiment 5.2 if you have collected all your data and have not done it already.)
- Answer questions in the Chapter 5 Review (You have two days to do this.)
- Finish answering questions in the Chapter 5 Review

Week 12:

- Check your answers for the review and study for the test
- Take the test for Chapter 5
- Read pp. 161-164
- Read pp. 165-169, stopping at Restriction fragment length polymorphism (RFLP)
- Read pp. 169-172

Week 13:

- Read pp. 173-176, performing Experiment 6.1 and stopping at the end of the experiment.
- Read pp. 176-181
- Read pp. 182-186, stopping at Section 6.11
- Read pp. 186-187 and spend some time reviewing the chapter
- Answer questions in the Chapter 6 Review (You have two days to do this.)

Week 14:

- Finish answering questions in the Chapter 6 Review
- Check your answers for the review and study for the test
- Take the test for Chapter 6
- Read pp. 191-194
- Read pp. 195-197, performing Experiment 7.1 and stopping at Section 7.2

Week 15:

- Read pp. 197-201
- Read pp. 202-205, stopping after the Comprehension Check questions
- Perform Experiment 7.2
- Read pp. 207-211, stopping at Gram-Positive bacteria
- Read pp. 211-216, stopping at the last paragraph on the page (“What about the other...”)

Week 16:

- Read pp. 216-218 and spend some time reviewing the chapter
- Answer questions in the Chapter 7 Review (You have two days to do this.)
- Finish answering questions in the Chapter 7 Review
- Check your answers for the review and study for the test
- Take the test for Chapter 7

Week 17:

- Read pp. 221-224, performing Experiment 8.1 and stopping after the Comprehension Check questions
- Read pp. 224-229, stopping after the Comprehension Check questions
- Read pp. 229-232, stopping at Experiment 8.2
- Perform Experiment 8.2
- Read pp. 235-240, stopping at Ascomycota (also called sac fungi)

Week 18:

- Read pp. 240-245, stopping at Experiment 8.3
- Perform Experiment 8.3
- Read pp. 246-249 and spend some time reviewing the chapter
- Answer questions in the Chapter 8 Review (You have two days to do this.)
- Finish answering questions in the Chapter 8 Review

Week 19:

- Check your answers for the review and study for the test
- Take the test for Chapter 8
- Read pp. 253-258, stopping at the third full paragraph (“If you walk along coastal...”)
- Read pp. 258-262, stopping at Experiment 9.1
- Perform Experiment 9.1 and answer the Comprehension Check questions that follow

Week 20:

- Read pp. 263-269, stopping at Section 9.7
- Read pp. 269-272, stopping at Experiment 9.2
- Perform Experiment 9.2 and answer the Comprehension Check questions that follow
- Read pp. 274-277, stopping at Experiment 9.3
- Perform Experiment 9.3 and answer the Comprehension Check questions that follow

Week 21:

- Read pp. 279-283, stopping at Section 9.10
- Read pp. 283-285 and answer questions 1-8 in the Chapter 9 Review
- Answer questions 9-25 in the Chapter 9 Review
- Check your answers for the review and study for the test
- Take the test for Chapter 9

Week 22:

- Read pp. 289-294, stopping at Section 10.4
- Read pp. 294-298, stopping at Experiment 10.1
- Perform Experiment 10.1 and answer the Comprehension Check questions that follow
- Read pp. 300-304, stopping at Section 10.6
- Read pp. 304-308, stopping at Experiment 10.2

Week 23:

- Perform Experiment 10.2 and answer the Comprehension Check questions that follow
- Read pp. 310-316
- Answer questions in the Chapter 10 Review (You have two days to do this.)
- Finish answering questions in the Chapter 10 Review
- Check your answers for the review and study for the test

Week 24:

- Take the test for Chapter 10
- Read pp. 321-324, stopping at Experiment 11.1
- Read pp. 324-326, performing Experiment 11.1 and stopping at Order Sphenodontia: tuataras
- Read pp. 326-332, stopping at Order Testudines: turtles, tortoises, and terrapins
- Read pp. 332-337

Week 25:

- Read pp. 338-340, performing Experiment 11.2 and answering the Comprehension Check questions that follow
- Read pp. 340-346, stopping at Monotremes
- Read pp. 346-351
- Answer questions in the Chapter 11 Review (You have two days to do this.)
- Finish answering questions in the Chapter 11 Review

Week 26:

- Check your answers for the review and study for the test
- Take the test for Chapter 11
- Read pp. 355-359
- Read pp. 360-362, stopping after Experiment 12.1
- Read pp. 362-366, stopping at Experiment 12.2

Week 27:

- Perform Experiment 12.2 and answer the Comprehension Check questions that follow
- Read pp. 367-371, stopping at Section 12.6
- Read pp. 371-375, stopping at Experiment 12.3
- Read pp. 375-377, performing Experiment 12.3 and stopping at Section 12.8
- Read pp. 377-381, stopping at Section 12.11

Week 28:

- Read pp. 381-383 and answer questions 1-10 in the Chapter 12 Review
- Answer questions 11-29 in the Chapter 10 Review
- Check your answers for the review and study for the test
- Take the test for Chapter 12
- Read pp. 387-392, stopping at Organs

Week 29:

- Read pp. 392-395, performing Experiment 13.1 and stopping at Section 13.2
- Read pp. 395-400
- Read pp. 401-403, performing Experiment 13.2 and answering the Comprehension Check questions that follow
- Read pp. 404-407, stopping at Experiment 13.3
- Perform Experiment 13.3 and answer the Comprehension Check questions that

Week 30:

- Read pp. 408-413, stopping at Seed-Making plants
- Read pp. 413-416 and answer questions 1-4 in the Chapter 13 Review
- Answer questions 5-12 in the Chapter 13 Review
- Check your answers for the review and study for the test
- Take the test for Chapter 13

Week 31:

- Read pp. 419-422, performing Experiment 14.1 and stopping at Section 14.2
- Read pp. 422-424, performing Experiment 14.2
- Read pp. 425-429
- Read pp. 430-434, stopping at Section 14.6
- Read pp. 434-439, stopping at Section 14.8

Week 32:

- Read pp. 439-443
- Answer questions in the Chapter 14 Review (You have two days to do this.)
- Finish answering questions in the Chapter 14 Review
- Check your answers for the review and study for the test
- Take the test for Chapter 14

Week 33:

- Read pp. 447-451, performing Experiment 15.1 and stopping at The Carbon Cycle
- Read pp. 451-458, stopping at Section 15.5
- Read pp. 458-462, stopping at Section 15.7
- Read pp. 462-464, performing Experiment 15.2 up to step 9
- Read pp. 464-466, finishing Experiment 15.2 and stopping at the last full paragraph (“If you were...”)

Week 34:

- Read pp. 466-473, stopping at Section 15.9
- Read pp. 473-475, performing experiment 15.3
- Answer questions in the Chapter 15 Review (Pay attention to the note on p. 478 highlighted in yellow!)
- Check your answers for the review and study for the test
- Take the test for Chapter 15

Week 35:

- Read pp. 479-484, stopping at Ecological Succession
- Read pp. 484-489, stopping at Section 16.4
- Read pp. 489-496, stopping at Section 16.7
- Read pp. 496-502, stopping at Experiment 16.1
- Perform Experiment 16.1

Week 36:

- Read pp. 503-508, stopping at Experiment 16.2
- Read pp. 508-509, performing Experiment 16.2. Also, answer questions 1-5 on the Chapter 16 Review
- Finish the Chapter 16 Review
- Check your answers for the review and study for the test
- Take the test for Chapter 16

Chapter 1 Comprehension Check Questions

1.1 You will learn later that DNA not only governs reproduction, but it also tells cells what chemicals they need to build and how to build them. In this role, does DNA direct anabolism or catabolism?

1.2 A dog is put in a very warm environment. At first, it reduces its activity and sweats a lot. After several weeks, however, it sheds a lot of its hair and is more active. Which would be considered adaptation? Which would be considered response to stimulus?

1.3 A mule is the offspring of a male donkey and a female horse. It cannot produce offspring, but it still has the sixth characteristic of life. Why?

1.4 Suppose you count all the members in one level of organization. How does the number of members of that level compare to the number of members of the level right below it? For example, if you are considering tissues, how does the number of tissues compare to the number of cells?

1.5 You randomly pick two organisms from a specific Class, and then you randomly pick out two organisms from a Family. In which case do you expect the organisms to be more similar?

1.6 A bear's full taxonomy is Domain Eukaryota, Kingdom Animalia, Phylum Chordata, Class Mammalia, Order Carnivora, Family Ursidae, Genus *Ursus*, Species *Ursus arctos*. Do bears have more in common with humans or domestic dogs?

12 Chapter 1 Comprehension Check Questions

1.7 A scientist finds a fossil and measures its dimensions, determines the minerals that make it up, and determines the characteristics of the rock in which it was found. She then looks to see if someone else has already found a fossil like hers. She then attempts to figure out the habitat in which the animal that left the fossil lived. Identify all of her activities as belonging to Experimental Science, Inferential Science, Philosophy of Science, or History of Science.

1.8 A farmer notices that his cows seem to produce more milk when they are fed in the morning. The later in the day they are fed, the less milk they produce. Based on this observation, what hypothesis could be made? What prediction could be made from it? How could that hypothesis be tested?

1.9 In which trophic levels can a carnivore be found?

1.10 When you eat a salad, what is your trophic level? What about when you eat meat from a cow?

1.11 Suppose an animal experiences a mutation that reduces its desire to reproduce. As a result, it is less likely to have offspring than other individuals of the same species. Do you expect that mutation to become prevalent in the population? Why or why not?

Chapter 1 Review Questions

1. Define the following terms:

- a. Irreducible complexity

- b. Metabolism

- c. Catabolism

- d. Anabolism

- e. Homeostasis

- f. Symbiosis

- g. Asexual reproduction

- h. Sexual reproduction

- i. Differentiation

- j. Taxonomy

- k. Prokaryotic cell

- l. Eukaryotic cell

- m. Energy

14 Chapter 1 Review Questions

- n. Producers
- o. Consumers
- p. Decomposers
- q. Natural selection
- r. Mutation

2. What are the seven characteristics of life?

3. The digestion process breaks down the molecules in food to make smaller molecules that cells can use for energy. Is this anabolism or catabolism?

4. Where does almost all the energy in biology come from?

5. If plant cells don't get enough water, they cannot stay rigid, and the plant wilts. Thus, if they start to lose rigidity, they absorb more water. Which characteristic of life is this an example of?

6. An animal changes its long-term behavior based on changes that occur in its environment. Which characteristic of life is this an example of?

7. What molecule transmits information from parent to offspring?

8. You started out as a single cell. However, you are now composed of trillions of cells. Which two characteristics of life produced that change?

9. Put these biological levels of organization in order, from the smallest to the largest:
biosphere, system of organs, molecule, organelle, ecosystem, cell, organ,
organism, tissue, population, community, atom, biome
10. List the eight divisions of taxonomy, starting with the broadest and ending with the narrowest.
11. You randomly choose two organisms from an order and compare them. You then randomly choose two organisms from the same genus and compare them. In which case do you expect the organisms to be more similar?
12. Here is the taxonomy of the domestic cat: Domain Eukaryota, Kingdom Animalia, Phylum Chordata, Class Mammalia, Order Carnivora, Family Felidae, Genus *Felis*, Species *Felis catus*. What is the scientific name for the domestic cat? When we name a species that way, what kind of nomenclature is being used?
13. The scientific name for a domestic dog is given in a textbook as *Canis Lupus Familiaris*. What's wrong with that?
14. When biologists attempt to correlate the organisms we see today to the original ones that were created, what is that called?
15. A teacher tells you that science has proven that the earth orbits the sun. Is the teacher correct?
16. Put these steps of the scientific method in their proper order: conclusion, observation, prediction, hypothesis, experimentation, analysis.
17. List the trophic levels in order, starting with those that directly use the sun's energy and ending with those that use the energy last.

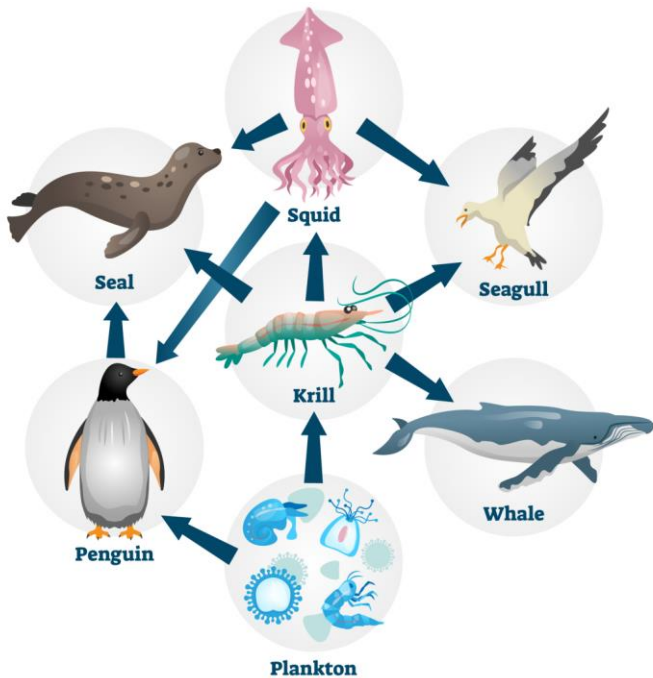

18. For the aquatic food web shown on the left answer the following questions:

- List the producers.
- What are the possible trophic levels of the penguin?
- What are the possible trophic levels of the whale?

19. A population of fish is being studied. In one generation, a few of the fish have a mutation that makes them faster swimmers. Others in that same generation have a mutation that makes it more difficult for them to perform metabolism. If the same population is studied two generations later, which mutation is more likely to be found in many of the fish?

20. Members of species A are able to mate and produce viable offspring with members of species B. Members of species C are unable to mate and produce viable offspring with members of either species A or species B. Which two species have the more similar DNA?

21. Based on the data we have right now, what is the main thing that natural selection accomplishes?

Chapter 2 Comprehension Check Questions

- 2.1 Nuclear chemists study the nucleus of the atom. Which particle in the atom do they ignore?
- 2.2 Ammonia is a compound in which a single nitrogen atom (abbreviated with “N”) shares electrons with three hydrogen atoms. Is it ionic or covalent? What is its chemical formula?
- 2.3 You probably know that oil doesn’t dissolve in water. Based on what you learned in this section, why is that?
- 2.4 In an experiment, a chemist gives the same amount of heat to water, alcohol, and oil. If they all started out at the same temperature, which will be the coolest at the end of the experiment?
- 2.5 Which of the following molecules would be a carbohydrate: $C_5H_{11}O_2$, $C_{12}H_{22}O_{11}$, C_6H_{14} ?
- 2.6 If a carbohydrate doesn’t taste sweet, which kind of saccharide is it most likely to be?
- 2.7 You are comparing the densities of two lipids. If one is saturated, and the other is unsaturated, which is less dense?
- 2.8 A lipid can dissolve in both water and oil. What kind of lipid is it?
- 2.9 Two proteins are studied. They are each composed of the same amino acids. However, they are very different chemically. How is this possible?
- 2.10 We listed six ways to group proteins based on their functions. To which group does catalase (the protein in the potato) belong?
- 2.11 Suppose we had you soak a potato slice in bleach instead of vinegar. Would that change the results of the experiment? If so, how?
- 2.12 One strand of DNA has bases in the following order: A – C – T – G – A. What is the order on the other strand?
- 2.13 There are 12 nucleotide bases in a strand of mRNA. How many codons are on the strand? How many amino acids will be specified by those codons?

Chapter 2 Review Questions

1. Define the following terms:

- a. Substance

- b. Atom

- c. Element

- d. Molecule

- e. Compound

- f. Hydrophilic

- g. Hydrophobic

- h. Cohesive

- i. Adhesive

- j. Carbohydrate

- k. Lipid

- l. Protein

- m. Nucleic acids

n. Replication

o. Transcription

p. Translation

q. Gene

2. In an atom, which particles are found in the nucleus? Which is found outside the nucleus?
3. An atom donates an electron to a different atom. What kind of bond is formed through this process?
4. Natural gas is composed of a carbon atom covalently bonded to four hydrogen atoms. What is its chemical formula?
5. Compare hydrogen bonds to covalent bonds.
6. Gasoline does not dissolve in water. Is it polar or nonpolar? Is it hydrophobic or hydrophilic?
7. Wax paper is covered with a nonpolar substance. Compare water's adhesive attraction to wax paper with its adhesive attraction to a paper towel.
8. Identify the carbohydrate in the following list of molecules: Na_2CO_3 , $\text{C}_2\text{H}_6\text{O}$, $\text{C}_8\text{H}_{16}\text{O}_8$, C_2HO .
9. When two monosaccharides are bonded together, what two substances are formed? What kind of reaction is this called?
10. Starch is an example of what kind of carbohydrate?

11. When three fatty acids chemically link to a molecule of glycerol, what kind of lipid is formed? What kind of reaction is this called? If the fatty acid molecules have double bonds between the carbon atoms, what kind of fat do they make?

12. The diagram on the right represents a phospholipid. Which letter indicates the hydrophilic portion of the molecule?

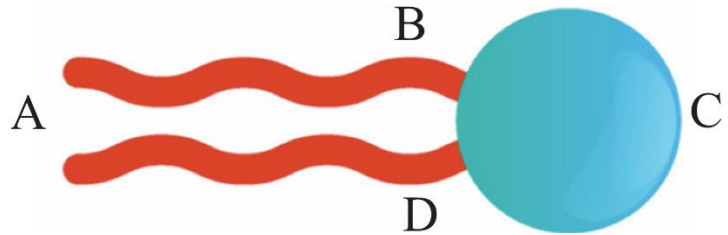

Which represents the hydrophobic side?

13. A molecule has an amino group, an acid group, and a side chain. To which group of biological molecules does it belong?

14. When two molecules like the one described in the previous question react so that there is a bond between the C in the acid group and the N in the amino group, what do we call the molecule that results? What do we call it when several such molecules do the same thing? What do we call the bond that links the C and N?

15. What is the primary structure of a protein?

16. Two proteins are both composed of seven different amino acids. Furthermore, the number of each of those amino acids is the same in both proteins. Are the proteins the same? Why or why not?

17. The pH of the solution in your stomach, called gastric juice, is 1. Is gastric juice an acid, base, or neither? The pH of pure water is 7. Is pure water an acid, base, or neither? The pH of ocean water is 8. Is ocean water an acid, base, or neither?

18. An enzyme is a specific type of what kind of molecule. What is an enzyme's function?

19. In the illustration of a DNA strand on the left, which letter:

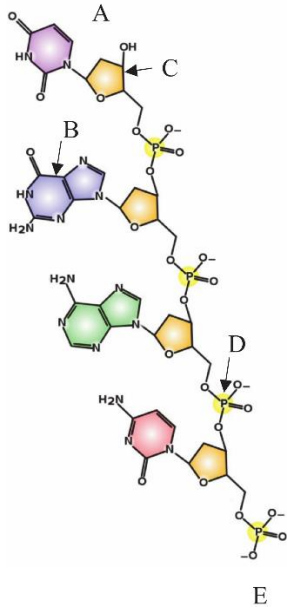

i. indicates a nucleotide base? _____

ii. is at the 3' end? _____

iii. is at the 5' end? _____

iv. indicates a sugar? _____

v. indicates a phosphate? _____

20. What kinds of bonds hold DNA's double helix together?

21. One strand of DNA has the following sequence of nucleotide bases:

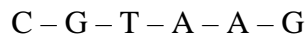

i. What sequence is on the strand on the opposite side of the double helix?

ii. If the sequence above were transcribed, what would be the sequence on the mRNA?

iii. How many amino acids would that strand of mRNA be translated into?

22. Nucleotide bases in RNA are attaching to a strand of DNA. Is this part of transcription or translation?

23. An mRNA molecule is at a ribosome. Is this part of transcription or translation?

24. A sample of sugar is all right-handed. Was it produced by a living organism or by processes that were not guided by a living organism?

25. What four steps must be explained by those who want to believe that life arose through chemical evolution. Have any of them been explained?

Chapter 3 Comprehension Check Questions

- 3.1 Those who wish to deny the existence of a Creator must believe that the first cell arose from spontaneous chemical reactions. Which part of cell theory does this belief violate?
- 3.2 Look back at the illustration of the plasma membrane. Based on where you see the cholesterol molecules, what can you say about the hydrophobic/hydrophilic nature of cholesterol?
- 3.3 Why do all cells (prokaryotic and eukaryotic) have ribosomes?
- 3.4 An organelle contains DNA. What are its possible identities?
- 3.5 A cell isn't making enough lipids. Which organelle (be specific) is not working?
- 3.6 One of the organelles you learned about is sometimes called the "suicide sac," because if it opens up, the cell dies. Which organelle is it?
- 3.7 A cell is put in sugar water where the concentration of sugar is much higher than it is in the cell. Is that an isotonic, hypertonic, or hypotonic solution? Since sugar cannot move across the plasma membrane, will water travel into or out of the cell?
- 3.8 The concentration of potassium is higher in a cell than in the water surrounding it. Nevertheless, potassium travels into the cell. Is this active transport or passive transport?
- 3.9 In the chloroplast, NADPH is being broken down. Is this part of the light-dependent reactions or the light-independent reactions?
- 3.10 In the chloroplast, ATP is being made. Is this part of the light-dependent reactions or the light-independent reactions?
- 3.11 Since photosynthesis has light-independent reactions, can the process happen when no light is available for an extended amount of time?

3.12 A C₅ molecule is losing a CO₂ to become a C₄ molecule in cellular respiration. Is this happening in glycolysis, the Krebs cycle, or the electron transport chain?

3.13 Many hydrogen ions are moving through ATP synthase in cellular respiration, producing many ATPs. Is this happening in glycolysis, the Krebs cycle, or the electron transport chain?

3.14 An organism doesn't have access to a final electron receptor molecule. Can it undergo any of the steps of cellular respiration? If so, which? What will have to happen to the products that are made?

3.15 Even those who believe that endosymbiotic theory is correct don't think that organelles like the Golgi, lysosome, and ER came from engulfed prokaryotic cells. Why?

Chapter 3 Review Questions

1. Define the following terms:

a. Plasma membrane

b. Ribosome

c. Pathogen

d. Flagellum

e. Diffusion

f. Osmosis

g. Endocytosis

h. Exocytosis

i. Aerobes

j. Anaerobes

k. Endosymbiosis

2. State the three main parts of cell theory.
3. In general, which is smaller: a prokaryotic cell or a eukaryotic cell?
4. How many layers of phospholipids are found in the plasma membrane? How are the molecules arranged?
5. What is the main function of the plasma membrane?
6. What three structures (not chemicals) discussed in the chapter can be found in all prokaryotic and eukaryotic cells?

7. Identify all the parts pointed out in the illustrations below:

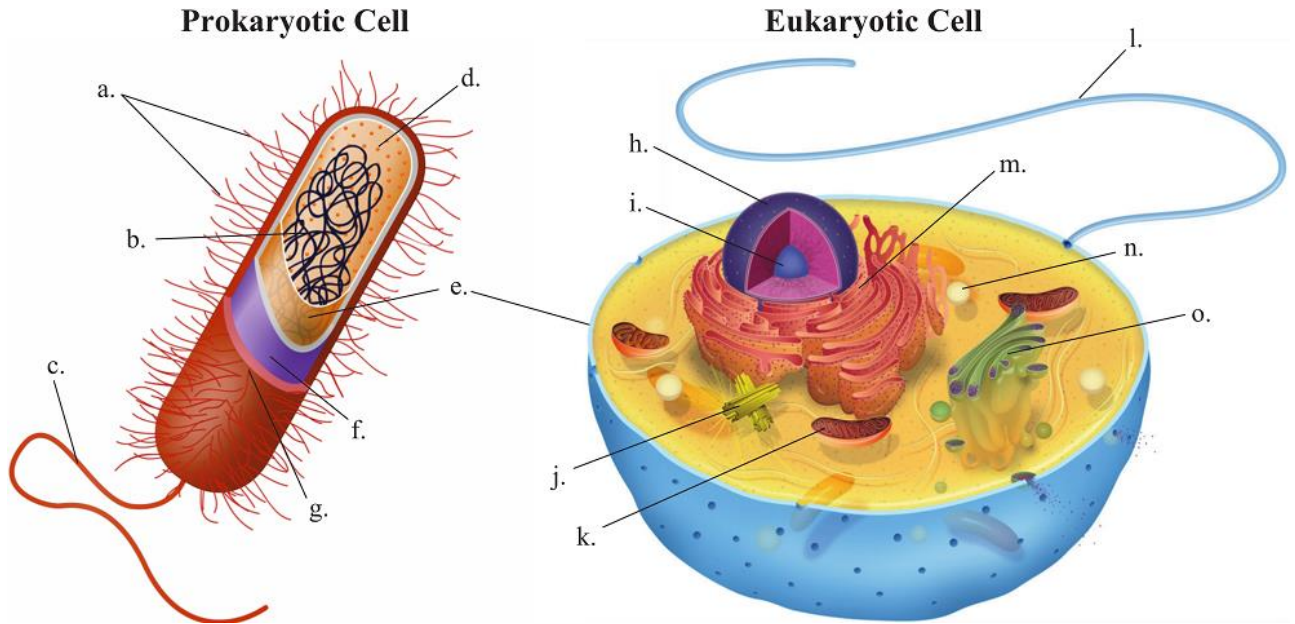

a)

b)

c)

d)

e)

f)

g)

h)

i)

j)

k)

l)

m)

n)

o)

8. What are the functions of structures c (and l), d, h, k, n, and o? For structure m, what two types exist, and what is the function of each?

9. What are the two main functions of the cytoskeleton?

10. What is the main function of the chloroplast?

11. In what organelles besides the nucleus can DNA be found?

12. Suppose a membrane surrounds a solution that has a solution of salt and water. It is put in a hypotonic solution. If the membrane is semipermeable, what will happen? If the membrane allows all substances to pass through, what will happen?

13. What is the abbreviation for the molecule that cells use when they need energy? What does the cell do to release that energy?

14. What is chlorophyll's role in photosynthesis? What chemicals are used up in photosynthesis, and what are made?

15. What chemicals are used up in aerobic respiration, and what chemicals are made?

16. In the light-dependent reactions of photosynthesis, what molecules are made and sent to the Calvin cycle? What is made and released into the atmosphere?

17. In the Calvin cycle, what chemical from the atmosphere is used up, and what chemical is made and used for food? What chemicals get sent back to be used in the light-dependent reactions?

18. What is the net number of ATPs made in glycolysis? If there is no oxygen available, what can the cell do so that energy can continue to be made through respiration?
19. If a cell performs glycolysis but does not continue on to the Krebs cycle, is it acting like an aerobe or an anaerobe?
20. After glycolysis, there are three processes that happen in the presence of oxygen. What are they called, and what is the net number of ATPs each generates?
21. In the Krebs cycle, what is the purpose of making NADH and FADH₂? To what process do they go?
22. In aerobic respiration, NADH is being turned into NAD⁺, while FADH₂ is becoming FAD. Which of the four processes is occurring?

Chapter 4 Comprehension Check Questions

- 4.1 A cell is synthesizing DNA in order to make a copy of its genome. Which phase of the cell cycle is it in? Would this be a part of interphase or mitosis?
- 4.2 A cell has just started mitosis. What is the last checkpoint that it passed?
- 4.3 A cell dies because it is in a hypertonic solution. Is this apoptosis? Why or why not?
- 4.4 An organism is asexually reproducing. The original cell is much larger than the new cell that is being formed. If your only choices are binary fission or budding, which is happening?
- 4.5 If a spindle fiber apparatus exists in a cell but the chromosomes are not near their duplicates, which stage of mitosis is the cell in?
- 4.6 The haploid set of an organism has 11 chromosomes. How many chromosomes are lined up at the equator during metaphase? Are they duplicated or unduplicated?
- 4.7 For the organism in question 4.6, how many chromosomes exist in each daughter cell? Are they duplicated or unduplicated?
- 4.8 A cell has its haploid set of DNA but still has its sister chromatids attached to one another. Has it been produced by meiosis I or meiosis II?
- 4.9 A cell's diploid set of DNA consists of 24 chromosomes. When it goes through both meiosis I and meiosis II, how many daughter cells will be produced? How many chromosomes will each daughter cell have?
- 4.10 Four gametes of equal size are formed. Is this the result of spermatogenesis or oogenesis?
- 4.11 A hermaphrodite self-fertilizes. Is the offspring genetically identical to the parent?
- 4.12 Like you, ASIMO needs energy in order to function. How efficiently do you think ASIMO uses its energy, compared to living organisms?

Chapter 4 Review Questions

1. Define the following terms:

- a. Mitosis
- b. Interphase
- c. Apoptosis
- d. Budding
- e. Cytokinesis
- f. Chromosome
- g. Karyokinesis
- h. Homologous Chromosomes
- i. Gamete
- j. Zygote
- k. Hermaphrodite
- l. Artificial intelligence

2. Describe the cell cycle, with its phases in the correct order and what happens in each phase. Also, where are the checkpoints along the way? Which phases occur during interphase?

3. What three kinds reproduction discussed in this chapter lead to two genetically-identical cells? Which kind is common in bacteria? Which is common in yeast? Which occurs in most eukaryotes?

4. List the five stages of mitosis in their proper order.

5. Indicate the stage of mitosis each drawing below represents.

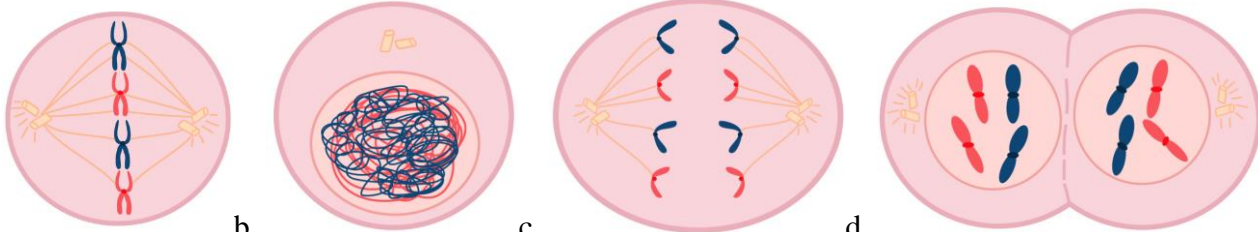

- a.
- a)
- b)
- b.
- c.
- c)
- d)
- d.

6. A cell's chromosomes are all shaped like an "X." Which stages of mitosis might be happening?

7. A cell has 46 chromosomes during prophase. How many chromosomes would be there if it had only its haploid set of DNA? How many chromosomes will be in the daughter cells at the end of mitosis, and how many daughter cells will there be?

8. What stage of mitosis has cytokinesis happening at the beginning of the stage?

9. A cell is undergoing telophase without a contractile ring. Is this a bacterial, plant, or animal cell?

10. A cell with 8 pairs of homologous chromosomes undergoes meiosis. At the end of meiosis I, how many cells will there be? How many chromosomes will be in each cell? Will those chromosomes be attached to their sister chromatids? At the end of meiosis II, how many cells will there be? How many chromosomes will be in each cell? Will those chromosomes be attached to their sister chromatids?

11. A cell with its diploid set of DNA has 28 chromosomes. If it undergoes mitosis, how many cells will there be, and how many chromosomes will each cell have? If it undergoes both meiosis I and meiosis II, how many cells will there be, and how many chromosomes will each cell have?

12. What process do eukaryotes use to make cells that will replace dead cells or to make cells that allow the organism to grow and develop? What process do they use to produce gametes?

13. A cell undergoes spermatogenesis. How many functional gametes will be formed?

14. A cell undergoes oogenesis. How many functional gametes will be formed?

15. Compare the sizes of a sperm and an egg.

16. Which contains mRNA: the sperm or the egg?

17. In the process of fertilization, what must the sperm do before it puts its DNA into the egg cell?

Chapter 5 Comprehension Check Questions

5.1 In pea plants, the allele that produces purple flowers is dominant, while the allele for white flowers is recessive. Write the two-letter genotype for the following genotypes: homozygous dominant, heterozygous, and homozygous recessive. For each of those genotypes, give the phenotype of the plant.

5.2 What are the possible phenotypes and their percentage chances of happening when a female that is heterozygous in both plant height and flower color is crossed with a male that is homozygous recessive in height and heterozygous in flower color?

5.3 What kind of inheritance is shown in the pedigree on the right, where the filled-in shapes represent individuals who have the phenotype of interest?

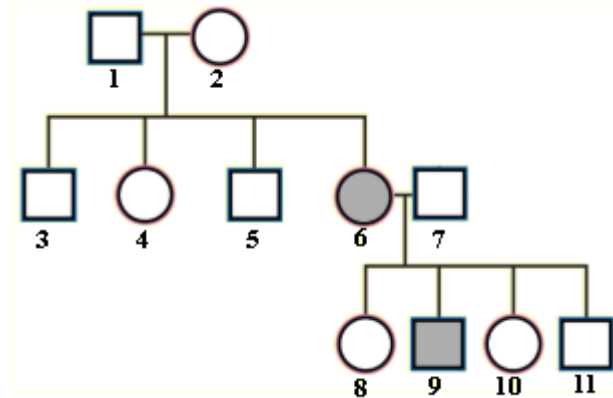

5.4 Using the words “homozygous,” “heterozygous,” “dominant,” and “recessive,” indicate the genotypes of individuals 1, 2, 6, and 7 when it comes to the trait of interest.

5.5 How does this pedigree tell us that the allele for the phenotype is *not* on the X-chromosome?

5.6 Produce a Punnett square for a cross between a mother with type A blood who is heterozygous and a father who has type O blood. What are the possible blood types for the children, ignoring the Rh factor?

5.7 A mother has type AB⁻ blood, while a father has O⁻ blood. Is it possible for them to have a child with type A⁺ blood? Why or why not?

- 5.8 Based on the variety that you see in people, is polygenetic inheritance rare or common in the human race?
- 5.9 Scientists often study identical twins to determine how much a person's environment plays a role in his or her characteristics. Why?
- 5.10 If two genes are linked, will a person always have both characteristics (like blonde hair and blue eyes)?
- 5.11 An organism's diploid set of DNA contains 30 chromosomes. If it produces gametes with 14 chromosomes, 15 chromosomes, and 16 chromosomes, which gametes are the result of nondisjunction that occurred during meiosis?
- 5.12 People have a gene that produces amylase, an enzyme that digests starch. Populations who have eaten a starch-rich diet for many years have as many as 20 amylase genes, while populations who do not eat a starch-rich diet can have as few as two. Which kind of mutation explains the difference?
- 5.13 A bacterium is resistant to an antibiotic, but it dies before it can reproduce. Nevertheless, the bacteria in the area become resistant to the same antibiotic. Assuming no mutations, how is this possible?
- 5.14 A point mutation produces a protein that is different from the normal protein by only one amino acid. How do we know this was a substitution mutation? Which kind of substitution mutation was it?
- 5.15 If the mutation discussed above is present in the organism's offspring, did it occur in a somatic cell or a germ cell?

Chapter 5 Review Questions

1. Define the following terms:

- a. Alleles

- b. Dominant allele

- c. Recessive allele

- d. Genotype

- e. Homozygous

- f. Heterozygous

- g. Phenotype

- h. Mutagen

- i. Monohybrid cross

- j. Dihybrid cross

- k. Autosome

- l. Pedigree

m. Law of Independent Assortment

n. Sex chromosomes

o. Sex-linked Disorder

p. Law of Segregation

2. In pea plants, the seeds (which are the peas) can be wrinkled or smooth. The allele that makes them smooth is dominant, while the allele that makes them wrinkled is recessive.

a. What is the genotype for a pea plant that is homozygous dominant? What is its phenotype?

b. What is the genotype for a pea plant that is heterozygous? What is its phenotype?

c. What is the genotype for a pea plant that is homozygous recessive? What is its phenotype?

3. Suppose a female pea plant that is heterozygous when it comes to the seed being wrinkled or smooth is crossed with a male pea plant that is homozygous dominant in the same trait. What are the possible genotypes and the percent chance of each? What are the possible phenotypes and the percent chance of each?

4. Remember that pea plants can produce yellow seeds, which are dominant, or green seeds, which are recessive. A female pea plant is heterozygous in both seed color as well as whether or not the seeds are wrinkled or smooth. If that pea plant is crossed with a male that produces wrinkled, green seeds, what are the possible phenotypes and the percent chance of each?

5. The pedigree on the right traces the presence of a particular phenotype.

a. How many individuals express the phenotype?

b. What pattern of inheritance does the phenotype follow?

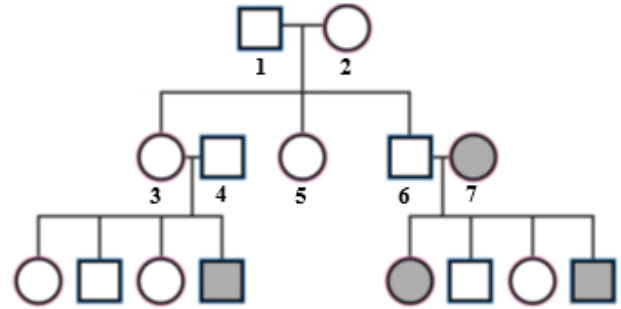

c. What are the genotypes of individuals 3, 4, 6, and 7? (Use P for the dominant allele and p for the recessive allele.)

6. A genetic disorder follows a sex-linked dominant inheritance pattern, and the allele that causes it is on the Y-chromosome. Can males have the disorder? What about females?

7. A genetic disorder follows a sex-linked recessive inheritance pattern, and the allele that causes it is on the X-chromosome. Can males have the disorder? What about females? Is one sex more likely to get it than the other? If so, which sex?

8. Remember that for blood type, A and B are dominant over O, but they are codominant with each other. Also, remember that the Rh factor is controlled by a second gene, with + being dominant and - being recessive. Suppose a mother with O^+ blood who is heterozygous when it comes to the Rh factor has children with a father who is type AB^- . What are the possible blood types in the children and the chance of each?

9. What does it mean for a trait to follow polygenetic inheritance? Does this lead to more or less diversity in that trait?

10. If identical twins have identical DNA, does that mean all their traits are identical? Why or why not?

11. In order for genes to be linked, what two conditions must be met?

12. When nondisjunction occurs in mitosis, can either of the daughter cells be normal? What if it happens in meiosis?
13. In a species of mammal, the genes that govern coat color are found on Chromosome 12. In one of the offspring, they are not found on that chromosome. Instead, they are found on Chromosome 11. What kind of mutation produced this effect?
14. If an offspring has more genes for a specific trait than its parents, what kind of mutation happened?
15. What do conjugation, transformation, and transduction have in common? What are their differences?
16. A point mutation causes a reading frameshift. How different is the protein that the mutant gene makes compared to the protein the unmutated gene makes?
17. A point mutation causes the protein being produced to be shorter than what it should be. What kind of mutation is it?
18. A point mutation causes a gene to make the same protein it made before the mutation. What kind of mutation is it?
19. What is the difference between somatic cells and germ cells? What is the importance of the difference when it comes to mutations?
20. An animal experiences a mutation. Most likely, what happened to the amount of information in its genome? Is it possible for the animal to be more fit to survive as a result of the mutation?

Chapter 6 Comprehension Check Questions

6.1 Which of the sections of DNA on the right is a palindrome?

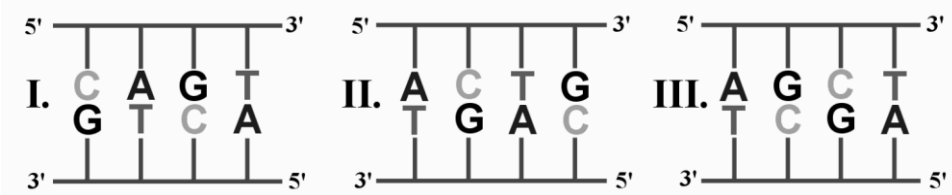

6.2 In gel electrophoresis, near which electrode will you find the longest pieces of DNA?

6.3 Cleaning a PCR testing area is particularly important. Why?



6.4 At the end of the Sanger process for DNA sequencing, the gel looks like what you see on the left. What is the nucleotide sequence for that section of DNA?

6.5 Would DNA fingerprinting or STR profiling be able to distinguish between identical twins? Why or why not?

6.6 A domestic cat named Rainbow was cloned in 2001. Her clone was named “CC” for “copy cat.” When CC reached the age that Rainbow was when she was cloned, did she look identical to Rainbow?

6.7 In the process of using induced pluripotent stem cells to treat an illness or injury, there is not only a de-differentiation process, but there must also be a differentiation process. Why?

6.8 Most of the transgenic organisms discussed are either bacteria or use bacterial genes. Why?

6.9 Scientists have found that the genes related to hearing in chimpanzees are very different from the genes related to hearing in a gorilla. Which part of that statement is a result of a study of comparative genomics? Which is a result of functional genomics?

6.10 In a CRISPR experiment, the inserted sequence of DNA appears where it is supposed to appear in the genome, but it also appears in places it shouldn't appear. What needs to be modified to fix this problem?

Chapter 6 Review Questions

1. Define the following terms:

- a. Biotechnology
- b. Recombinant DNA
- c. Genetic engineering
- d. Plasmid
- e. Transgenic
- f. Cloning
- g. Reproductive cloning
- h. Therapeutic cloning
- i. Stem cell
- j. Gene therapy
- k. Genomics
- l. Proteomics

2. What is a bacteriophage and how does it attack bacteria?

3. Which of the following DNA segments is a palindrome?

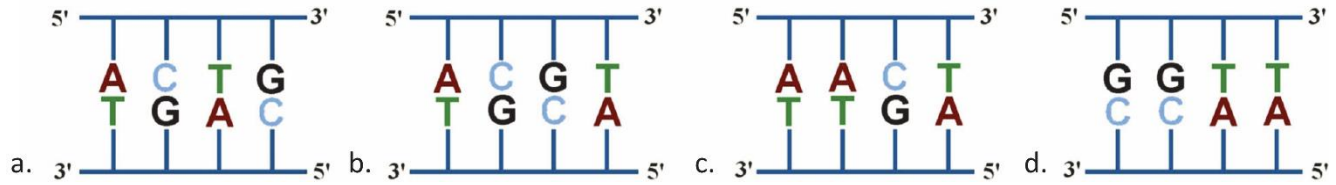

4. What does a restriction enzyme do to DNA? What other name is used to refer to it?

5. For the electrophoresis gel on the right, answer the following questions:

a. Which Roman numeral indicates the band with the highest number of DNA segments?

b. Which Roman numeral indicates the band with the lowest number of DNA segments?

c. Which Roman numeral indicates the longest segments of DNA?

d. Which Roman numeral indicates the shortest segments of DNA?

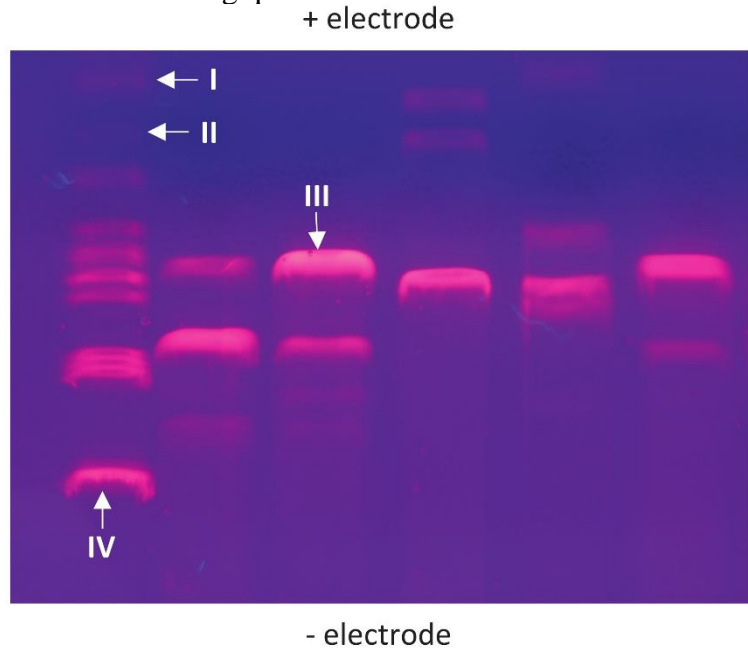

6. What are the three steps of the PCR process, in order?

7. When PCR is used to test for a viral infection, will adding cycles increase or decrease the sensitivity for detecting the presence of viral RNA or DNA? Why?

8. A small segment of DNA is sequenced using the Sanger Method. The final gel looks like what is shown on the right. What is the sequence of nucleotides on the segment?

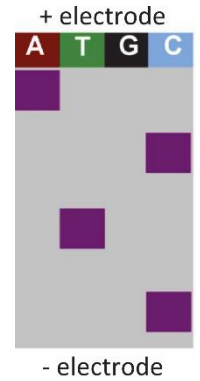

9. What is the more common term for a restriction fragment length polymorphism (RFLP)?

10. What are STRs, and how can they be used to distinguish between different people?

11. What kinds of people can RFLPs and STR not tell apart?

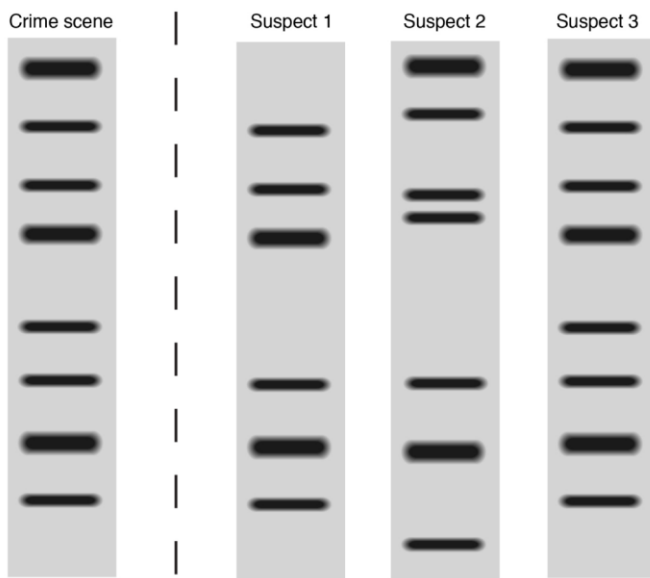

12. The image on the left shows a DNA fingerprint taken from a crime scene and the DNA fingerprints of three suspects. Which is a match to the crime scene sample?

13. When a gene from an animal, plant, or human is inserted into a bacterium, what vector is used?

14. What produces the human insulin that is used to treat diabetics?

15. How many animals are required in order to clone an animal? What is the role of each? Which is the one actually being cloned?

16. A cat named CC is famous for being cloned from an adult cat. If you compared CC to the cat from which she was cloned (at the same age), would they look the same? Why or why not?

17. What is the ethical difference between using embryonic stem cells for therapy and adult stem cells for therapy?

18. What is an induced pluripotent stem cell? Ethically, to which of the two types of stem cells listed in the previous question is it most similar?

19. Distinguish between *in vivo* and *ex vivo* gene therapy.

20. List each of the following as comparative genomics, functional genomics, or proteomics.

a. Determining what a DNA sequence does in an organism

b. Studying the proteins that an organism produces

c. Determining the differences in DNA between a butterfly and a moth

21. What does the guide RNA do in CRISPR? To what enzyme is it attached?

22. CRISPR can insert genes to produce transgenic organisms, but what else can it do to genes?

23. From a bioethics point of view, what is the problem with making transgenic people?

Chapter 7 Comprehension Check Questions

- 7.1 Even without the caption, you should know that the image in the left of Figure 7.2 as well as the one in the middle cannot be from organisms in domains Archaea or Bacteria. Why?
- 7.2 Beef bouillon has a lot of protein in it. If you wanted to culture bacteria that are very different from the ones being cultured in your experiment, what household food item might you use instead?
- 7.3 You have a prokaryote, but you don't know if it belongs in domain Archaea or domain Bacteria. What chemical could you test for to find out? If you found that chemical, to what domain would the prokaryote belong?
- 7.4 Beans contain certain carbohydrates that are very hard for people to digest. Can you suggest why they cause flatulence in many people?
- 7.5 If you looked at *Prochlorococcus* (the cyanobacteria that produce much of the oxygen in the atmosphere) under the microscope, what would their shape be?
- 7.6 Bacteria are being cultured in an artificial environment with no oxygen. After several days, air (but no new bacteria) leaks into the environment. After several more days, the bacterial cultures are examined. If there are still living bacteria in a culture, what kind of bacteria are they?
- 7.7 An enteric bacterium undergoes a gram stain. What color will it have when viewed with a microscope?
- 7.8 You are examining bacteria that are one of the following: gammaproteobacteria, firmicutes, or cyanobacteria. If they are gram-positive, which type are they?
- 7.9 A cell is releasing newly-made viruses. Is it in the lytic or lysogenic cycle?
- 7.10 An infectious agent is smaller than a virus but has no nucleic acids. What is it?
- 7.11 Most evolutionists don't believe that the Archaea were the first living organisms on the planet. Instead, they think something simpler must have originally been formed, and that simpler organism evolved into something like the Archaea. However, no examples of this simpler organism have been found. How might an evolutionist explain this lack of evidence?

Chapter 7 Review Questions

1. Define the following terms:

a. Microscopy

b. Culturing

c. Broth culture

d. Agar culture

e. Extremophiles

f. Endospore

g. Normal flora

h. Obligate aerobes

i. Obligate anaerobes

j. Facultative anaerobes

k.Serology

l. Strain

m. Nitrogen fixation

n.Lytic cycle

o.Lysogenic cycle

2. You want to examine an organelle in a cell. Would you use a light microscope, TEM, or STM? What if you wanted to examine an entire eukaryotic cell?
3. When a Gram stain is applied, what colors will you see and what do we call the bacteria with each color?
4. What do we call it when we add a sample of bacteria to a culture?
5. What is the main thing used to distinguish between domains Archaea and Bacteria?
6. What are the four groups of extremophiles and what are the characteristics of each?
7. What is the main method of reproduction among bacteria?

8. If you look at *Lactobacillus acidophilus* bacteria under the microscope, what would their shapes be? What about *Agrococcus terreus*? What about *Herbaspirillum huttiense*?

9. Why are cyanobacteria important for life on this planet?

10. A bacterium that is part of the normal flora becomes toxic but is the same strain. Most likely, what made it become toxic?

11. For the following groups, indicate whether they are gram-positive or gram-negative: gammaproteobacteria, firmicutes, nonproteobacteria, actinobacteria.

12. How many different types of bacteria are needed to take nitrogen from the air and convert it into nitrate, which some plants need to survive?

13. List the following in order of size, starting with the smallest: bacteria, prions, viruses.

14. What macromolecules make up a virus? Which type enters the cell to cause an infection?

15. What do ssDNA, dsDNA, ssRNA, and dsRNA mean?

16. If a virus infects someone but doesn't produce symptoms for many years, did it initially enter the lytic cycle or the lysogenic cycle?

17. Are all viruses pathogens?

Chapter 8 Comprehension Check Questions

- 8.1 A protist is part of the ocean's phytoplankton. Is it part of the protozoa, algae, or slime molds?
- 8.2 If a protist in fresh water has a contractile vacuole that isn't active enough, what will it die of? What will it die of if its contractile vacuole is *too active*?
- 8.3 A protist has a cell wall that contains silica. Can it perform photosynthesis?
- 8.4 If a protist has a macronucleus and a micronucleus, what does it use for movement?
- 8.5 An organism is made of cells that are haploid. Is it in the sporophyte or gametophyte stage of its alternation of generations cycle? What kind of reproductive cells (spores or gametes) will it make?
- 8.6 In an alternation of generations cycle, meiosis is used to make spores. Is the organism made of haploid or diploid cells?
- 8.7 If an amoeba looks like a smooth oval under the microscope, is it in the process of moving?
- 8.8 If a fungus and its offspring are genetically identical, which of the following could *not* have been the method of reproduction: fragmentation, asexual spore formation, plasmogamy followed by karyogamy, or budding?
- 8.9 Which has more aerial hyphae: a mold or a fleshy fungus?
- 8.10 For each of the following, indicate whether the spores it releases are from sexual or asexual reproduction: zygosporangium, conidiophore, basidiocarp, sporangia, ascocarp.
- 8.11 What kind of sac fungi don't produce ascocarps?
- 8.12 What kind of fungus makes spores that have flagella?
- 8.13 A fungus produces a mycosis. Is its relationship with its host an example of mutualism, commensalism, or parasitism? What about the relationship in a lichen? A mycorrhiza?

Chapter 8 Review Questions

1. Define the following terms:

- a. Cytolysis

- b. Plasmolysis

- c. Diatoms

- d. Dinoflagellates

- e. Pseudopod

- f. Plasmodium

- g. Mycology

- h. Fruiting body

- i. Vegetative structures

- j. Mold

- k. Saprotrophs

- l. Ascocarp

m. Pasteurization

n. Basidiocarp

o. Hallucinogen

p. Parasitism

q. Commensalism

r. Phylogenetics

2. What are the three groups of protists, and how are they described? Which group contains zooplankton? Which contains phytoplankton?

3. List the three defining characteristics for members of genus *Euglena*.

4. What does the contractile vacuole do in protists?

5. The remains of what kind of protist can be used as a gentle abrasive, such as what is found in toothpaste?

6. Which protists live in a symbiotic relationship with coral? Is it an example of mutualism, commensalism, or parasitism?

7. What genus of organisms is responsible for malaria?

8. List the three defining characteristics of members of genus *Paramecium*.

9. What kind of symmetry is found in the radiolarians? What is often associated with large amounts of their remains?

10. In alternation of generations, are the cells of the gametophyte haploid or diploid? What kind of reproductive cells does it form? Are the cells of the sporophyte haploid or diploid? What kind of reproductive cells does it form? What must happen for a zygote to form in this kind of reproduction?

11. In genus *Volvox*, what shape do the individuals join together to form? If you see dark circles inside that shape, what are they?

12. In genus *Spirogyra*, what shape do the chloroplasts make?

13. Are the hyphae in a mature fungus typically haploid or diploid? Does it use mitosis for asexual reproduction or sexual reproduction? Does it use plasmogamy followed by karyogamy for asexual or sexual reproduction? Is the fruiting body formed in asexual or sexual reproduction?

14. What is found in the cell walls of fungi that can also be found in certain animals? What does it provide for the fungus?

15. What is the defining characteristic of microsporidians?

16. What is the defining characteristic of the Chytridiomycota?

17. What is the defining characteristic of the Zygomycota?

18. What is the defining characteristic of the Ascomycota? What members of this group don't actually have that characteristic?

19. What is the defining characteristic of the Basidiomycota?
20. Why would a fungus be identified as a member of the Deuteromycota?
21. Describe the mutualistic relationship found in lichens.
22. Describe the mutualistic relationship found in mycorrhizae.
23. For each of the following, indicate whether it is from the Chytridiomycota, Zygomycota, Ascomycota, or Basidiomycota:
 - a. Shelf fungus
 - b. Bread mold
 - c. Members of genus *Penicillium*
 - d. Mushrooms
 - e. Members of genus *Aspergillus*
24. What is a phylogenetic tree? What often happens when phylogenetic trees are made from different groups of genes and then compared?

Chapter 9 Comprehension Check Questions

- 9.1 A male gamete and female gamete from the same hermaphroditic organism undergo fertilization. Will the result be the same as if the organism reproduced asexually?
- 9.2 If cells far from a sponge's choanocytes aren't getting food, what cells aren't doing their job?
- 9.3 A cnidarian is being studied. It looks very different from its medusa stage and its polyp stage. What is the term for what it is right now?
- 9.4 Looking at Figure 9.5, compare the thickness of the mesoglea in the polyp and medusa stages. In which stage is it thicker?
- 9.5 A fluke infects four different species of animal in its life cycle. How many of them are intermediate hosts?
- 9.6 A planarian reproduces by regeneration. Will the genomes of the offspring be different from or identical to the genome of the planarian?
- 9.7 If an echinoderm's water system stops working, what else will stop working as well?
- 9.8 You find a mollusk's shell. There is no visceral mass anymore, but you are told it is either from a gastropod or a bivalve. How can you determine which it is from?
- 9.9 If you are looking at a worm, how can you tell whether it is from phylum Nematoda or phylum Annelida?
- 9.10 Why is the gizzard the most muscular of all the organs in the earthworm's digestive system?
- 9.11 Crabs are crustaceans, and some people call them "ocean spiders" because they look a bit like spiders. Given that crabs are crustaceans, name at least two differences between crabs and spiders.
- 9.12 An insect has two pairs of membranous wings. To what order does it belong?

Chapter 9 Review Questions

1. Define the following terms:

- a. Ectothermic organism

- b. Hermaphroditic

- c. Metamorphosis

- d. Bilateral symmetry

- e. Radial symmetry

- f. Open circulatory system

- g. External fertilization

- h. Internal fertilization

- i. Closed circulatory system

- j. Molting

- k. Compound eye

- l. Simple eye

- m. Pollinator

2. What kind of skeleton does a vertebrate have? If an invertebrate has a skeleton, what is it called, and what is it usually made of?
3. How do sponges feed? What protein is their support structure made of?
4. What are choanocytes and amoebocytes? In what animals are they found and what do they do?
5. What are the three layers of tissue in a cnidarian?
6. What distinguishing structures are found on the tentacles of a cnidarian?
7. If a cnidarian is a planula, what stage of its life cycle was it in previously? What stage comes next?
8. Describe the relationship between the sea anemone and the clownfish. What kind of symbiosis is it (parasitic, commensal, or mutualistic)?
9. What is the difference between an incomplete digestive system and a complete digestive system?
10. To what phylum do flatworms belong? What genus did we concentrate on? What is the mode of asexual reproduction in members of that genus?
11. Explain the difference between an intermediate host and a primary host in a parasite.
12. What is a proglottid and in what flatworm can proglottids be found?

13. What phylum contains invertebrates with spiny skin and tube feet? What is unusual about the stomachs of these invertebrates?

14. What phylum contains invertebrates with bodies that can be divided into a head, a visceral mass, a strong muscular foot, and a mantle?

15. How do you distinguish between gastropods, cephalopods, and bivalves?

16. What phylum contains the roundworms?

17. What phylum contains the segmented worms?

18. What phylum contains the most species?

19. Identify the structures in the earthworm model below:

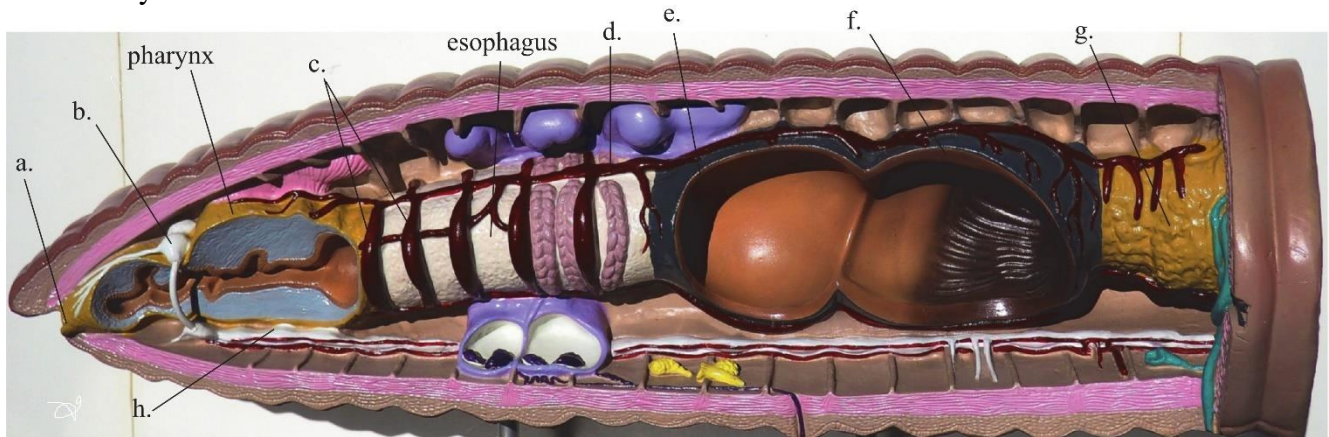

- a) e)
- b) f)
- c) g)
- d) h)

20. What are the distinguishing characteristics of members of phylum Arthropoda?

21. What are the distinguishing characteristics of arachnids?

22. What are the distinguishing characteristics of crustaceans?

23. What are the distinguishing characteristics of insects?

24. What are the distinguishing characteristics of myriapods?

25. What is the Cambrian Explosion and why is it such a problem for evolution?

Chapter 10 Comprehension Check Questions

10.1 Scuba divers wear a vest to control their depth in the water. They fill the vest with air to rise to shallower depths and let air out to sink to deeper depths. What fish organ functions in the same way?

10.2 You have part of a person's skeleton and part of a lamprey's skeleton. The two parts are the same shape and size. What could you do to determine which came from the lamprey?

10.3 Are people oviparous, viviparous, or ovoviviparous?

10.4 Which fin on the shark sticks above water when it is swimming near the surface?

10.5 You should have noticed in your dissection that the operculum is hard. Why?

10.6 The heart beats to push blood through the blood vessels. Based on the fact that the walls of the two chambers are of different thickness, which chamber (the atrium or ventricle) is responsible for most of the pushing?

10.7 Are seahorses viviparous, oviparous, or ovoviviparous?

10.8 What does the coelacanth teach us about the things scientists conclude when studying only the fossils of an organism?

10.9 In one stage of life, an amphibian has lungs. In another stage, it has only gills. Which of these two stages is the adult stage?

10.10 An amphibian has a tail. Must it be in order Caudata? Why or why not?

10.11 When would you expect a frog to have the most fat bodies?

10.13 If you see a frog with coloration like a poison dart frog, can you be certain that it produces poison? Why or why not?

10.14 If an amphibian has no tail as an adult and can jump really far, will its skin most likely be smooth and wet or bumpy and dry?

10.15 Are caecilians oviparous, viviparous, or ovoviviparous?

Chapter 10 Review Questions

1. Define the following terms:

- a. Spawning

- b. Cartilage

- c. Pineal eye

- d. Cloaca

- e. Ovoviviparous

- f. Oviparous

- g. Viviparous

- h. Gonad

- i. Anadromous

- j. Cleaning station

- k. Tetrapod

- l. Extinct

- m. Extant

- n. Living fossil
- o. Spermatophore
- p. Aposematic coloration
- q. Mimicry

2. List the eight characteristics shared by most fish.
3. What is the function of the swim bladder? What about the lateral line?
4. What are the agnathans also called? What two specific examples were covered in the book? What are the differences between them when it comes to the mouth?
5. What are the Chondrichthyes also called? What three types of fish belong to this group?
6. In terms of their endoskeletons, what do the agnathans and Chondrichthyes have in common?
7. What is the name of the structures that sharks use to detect electrical fields? Why does this help the shark?
8. What is the technical name for the shape of a shark's tail?
9. Which fins are enlarged in rays and skates?

10. Identify the structures pointed out below:

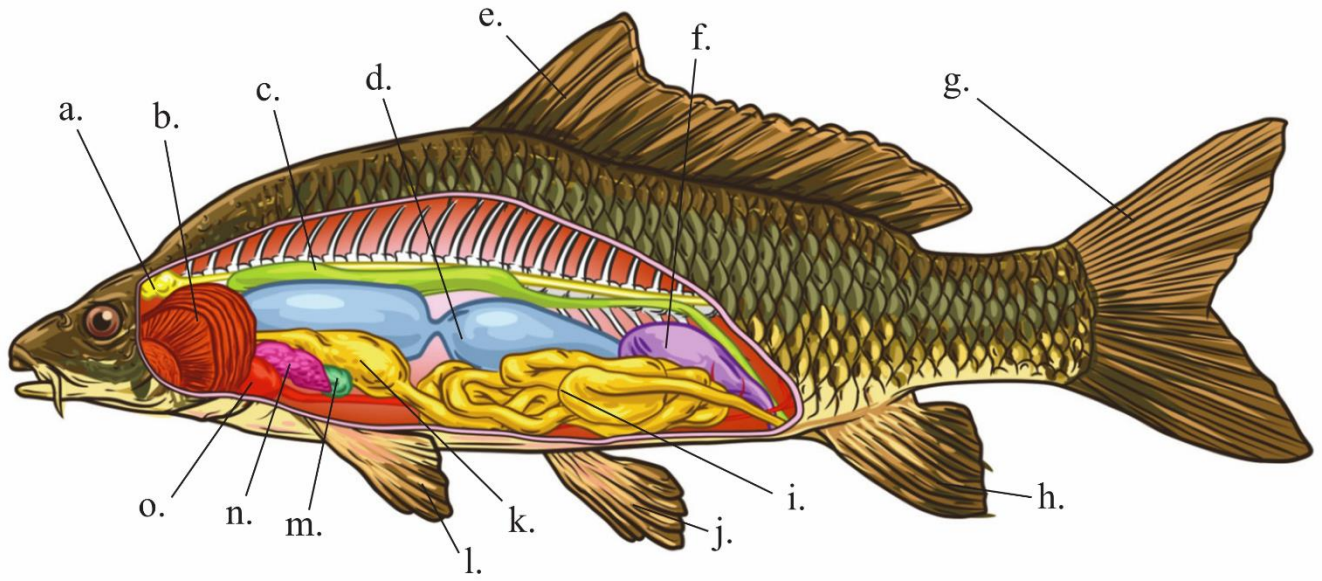

a)

i)

b)

j)

c)

k)

d)

l)

e)

m)

f)

n)

g)

o

h)

11. What two groups are the bony fish divided into? What is the main difference between them? For each of the following, indicate which of the two groups it belongs to: tuna, cod, coelacanth, seahorse, lungfish.

12. What are the six general characteristics of amphibians?

13. What are the three orders into which amphibians can be divided? What are the main differences among them?

14. Identify the order to which each of the following belongs: frogs, salamanders, caecilians, toads, newts.

15. What is the difference between the skin of a frog and that of a toad?

16. What type of animal do evolutionists think evolved into amphibians?

17. What is *Tiktaalik* and what do evolutionists think it was? Why do they think that? What's wrong with that line of thought?

Chapter 11 Comprehension Check Questions

11.1 Reptiles are sometimes seen “sunning” themselves, which means they lie in bright patches of sunlight. Why would they do that?

11.2 In an amniotic egg, the embryo grows as it matures. What happens to the size of the yolk and the allantois while the embryo is growing?

11.3 A reptile has no eyelids or external ears. In what order is it found? What is the common name?

11.4 A reptile has scutes on the skin of its back. To which order does it belong?

11.5 Sea turtles only leave the ocean to lay eggs, but they must regularly rise to the surface of the ocean. Why?

11.6 The bones of other vertebrates are solid. Why are bird bones hollow?

11.7 Baby birds often look very fluffy until they get older. What gives them that appearance?

11.8 If you see only a bird’s feet, how could you tell if it is a raptor, songbird, or waterfowl?

11.9 If you have only the brain to examine, how would you tell if it came from a mammal?

11.10 If a baby animal is born live but is very small and not well-developed, which of the three types of mammals probably produced it?

11.11 Of the animals drawn in Figure 11.30, which appear capable of flight? Why is that a problem for evolution?

2. Among the reptiles, birds, and mammals, which are endothermic?

Which are ectothermic?

Which have scales or scutes, which have feathers, and which have hair?

Which lactate?

3. Identify the structures pointed out in the amniotic egg shown on the right.

a)

b)

c)

d)

e)

f)

g)

h)

i)

j)

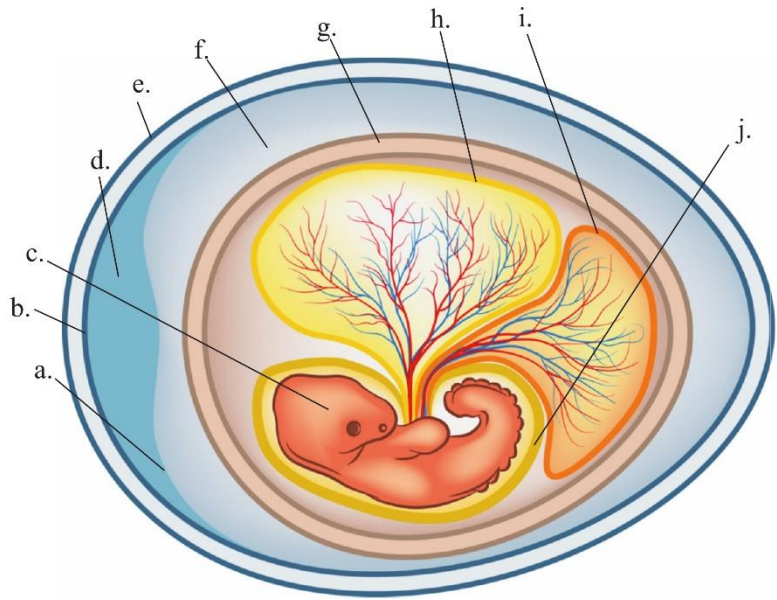

4. What is the function of structure “h?”

5. What is the difference in structure “e” when comparing a reptile egg to a bird egg?
6. What are the features that separate Crocodylians from the other reptiles?
7. What do we call the members of the only genus in order Sphenodontia? What three characteristics separates them from other reptiles?
8. What two characteristics separate members of order Squamata from the other reptiles?
9. What three things do lizards have that snakes do not?
10. Contrast the way constrictors, venomous snakes, and non-venomous snakes kill their prey.
11. Why does a snake stick out its tongue? Why is the tongue forked? What organ does the snake use along with its tongue?
12. What two characteristics separate the members of order Testudines from the other reptiles?
13. What determines whether a member of order Testudines is a turtle, tortoise, or terrapin?
14. What thing has been found in dinosaur fossils that provides evidence they are not millions of years old?
15. In a feather, what structures make up the vane? Which structure is attached to the central shaft? Which structure can have hooks?

16. What characteristic does the central shaft of a feather share with a flying bird's bones?

17. What are the three types of feathers discussed in this chapter? Which has the least barbule interaction?

18. What is the function of the keel in a flying bird? What about the furcula?

19. What characteristics separates the mammal brain from the brains of other vertebrates?

20. What is the difference between the way reptiles and mammals breathe compared to the way birds breathe?

21. When it comes to the way they nourish their developing babies, what are the differences among placental mammals, monotremes, and marsupials?

22. In the placenta, does the baby's blood ever mix with the mother's blood? Why or why not?

23. If a mammal gives birth to seven babies, how many placentas did she have?

24. According to the evolutionary timeline, what problem does *Archaeopteryx* pose to the idea that dinosaurs evolved into birds?

25. What would have to happen to the way the animals breathe in order for dinosaurs to evolve into birds?

Chapter 12 Comprehension Check Questions

12.1 Is the animal pictured on the right a monkey or an ape?



12.2 Those who believe that humans evolved from an apelike ancestor are on the lookout for fossils of apelike animals that could walk on two legs more comfortably than extant apes. Why?

12.3 For a typical neuron, which part of the cell gets a signal first? To what part of the cell does it go next? What is the last part of the cell to have the signal? If the signal must get to another neuron, what must it pass through?

12.4 As blood stem cells differentiate, those that become erythrocytes eject their nucleus, which is why you saw no nuclei in your erythrocytes. Can you think of a reason why they would do that?

12.5 If erythrocytes have no nucleus, how can we test a person's blood for DNA?

12.6 When a person is exposed to a pathogen and fights it off with acquired immunity, there are antibodies against that pathogen circulating in the blood for a while. However, they are eventually destroyed by your liver. Once the antibodies are gone, is the person unprotected from the pathogen? Why or why not?

12.7 The digestive system is often split into the digestive tract (which contains all the organs the food actually passes through) and the accessory organs (which perform digestive functions but food doesn't pass through them). Using the organs pointed out in Figure 12.13, list the ones that belong to the digestive tract.

12.8 When someone smokes a lot, it destroys alveoli in the lungs. The more that person smokes, the more alveoli get destroyed. What would the person notice as this happens over time?

12.9 Suppose fluid is traveling through the nephron. It has Vitamin C in it, which the body needs. It also has urea in it, which is a nitrogen-containing molecule produced by metabolism. As the liquid travels through the nephron, what happens to the amount of Vitamin C in it? What happens to the amount of urea in it?

12.10 Dr. Esteban Sarmiento, an expert in primate biology, once wrote this about the many hominid fossils being discovered in Africa: "...it is curious that in a century-old race for superlative hominid fossils on a continent currently populated with African apes, we consistently unearth nearly complete hominid ancestors and have yet to recognize even a small fragment of a bona fide chimpanzee or gorilla ancestor." (Esteban E. Sarmiento, "Comment on the Paleobiology and Classification of *Ardipithecus ramidus*," *Science* **328**:1105, 2010). This statement implies something about current attempts to understand human evolution. What does it imply?

Chapter 12 Review Questions

1. Define the following terms:

a. Quadrupedalism

b. Brachiation

c. Bipedalism

d. Antibody

e. Vestigial organ

f. Mechanical digestion

g. Chemical digestion

h. Hominid

i. Hominin

2. What distinguishes monkeys from apes?

3. What is knuckle walking?

4. What advantage does binocular vision provide? What disadvantage comes with it?

5. What skeletal features of a human contribute to bipedalism?

6. What are the two main organs of the CNS? What two types of nerves are found in the PNS?

7. Why can a reflex happen so quickly?

8. What are the two types of cells in the brain?

9. In a neuron, which part often receives the signals? Which part contains the organelles? Which part often sends the signals to their next destination?

10. What is the connection between two neurons called?

11. What is the function of erythrocytes? What is their common name? What do most cells have that they don't have?

12. What is the function of leukocytes? What is their common name?

13. Starting with blood coming back to the heart from the lungs, indicate which chambers of the heart it passes through and in which order. Also indicate when it goes to the tissues, when it goes to the lungs, when it is rich in oxygen, and when it is poor in oxygen.

14. In which direction does blood flow through the veins? What about the arteries? What does blood travel through when it is in between veins and arteries? What happens then?

15. What two types of immunity does your immune system give you?

16. What are the five lymphoid organs? What does each of them do?

17. Which of the two types of immunity are memory B-cells and memory T-cells associated with?

18. Starting with the mouth, list the organs of digestion through which food travels (in order) until it leaves the body.

19. What is the function of bile, and what organ makes it?

20. What is the main muscle associated with breathing? When it relaxes, do you inhale or exhale? What other muscles can come into play?

21. Where does the exchange of oxygen and carbon dioxide occur in the lungs? What single word describes the process by which the exchange occurs? What is maximized to make sure it happens quickly?

22. What is a nephron, and in what organ is it found?

23. A chemical enters a nephron at the Bowman's capsule and ends up making it all the way to the collecting duct. Assuming everything is working properly, is that a chemical the body needs? What if it didn't make it to the collecting duct?

24. Members of which gender can produce gametes from sexual maturity until they get very old? Which gender has a limited number of potential gametes?

25. In what two organs are the hormones that govern the human reproductive system made?

26. What is menopause?

27. What is the *Imago Dei*? In what organisms can it be found?

28. What problem does human exceptionalism pose to someone who doesn't believe in a Creator?

29. Order the following four genera in terms of when they are supposed to have appeared in the human evolutionary line: *Homo*, *Ardipithecus*, *Sahelanthropus*, *Australopithecus*. Start with the one that appears first.

Chapter 13 Comprehension Check Questions

13.1 You have two plants of the same species. One is wilted, the other is not. In which plant are the cell's central vacuoles smaller?

13.2 Suppose you are looking at a living plant under a microscope. You see a lot of mitosis taking place. What kind of cells are you probably observing?

13.3 Based on the descriptions given, which of the four basic tissues makes up most of a plant?

13.4 Some biologists use the term “perfect flower” to describe a flower based on the structures that it contains. Which structures do you think must be present for a flower to be “perfect”?

13.5 Even though the roots pictured on the corn plant in Figure 13.8 are close to the ground, they are still considered adventitious roots. Why?

13.6 If a tree's roots are above ground, are they definitely aerial roots? Why or why not?

13.7 A large hole drilled through a tree trunk will not kill the tree, especially if it is sealed up so that parasites can't get in. Why?

13.8 Suppose you could see material as it travels through the vascular tissue of a stem. In a given bundle of vascular tissue, the material always moves towards the leaves on one part of the bundle, and it moves in both directions in another part. Which part is closer to the center?

13.9 As you saw in the experiment, and as shown in Figure 13.16, stomata are generally on the underside of a leaf. Why?

13.10 In most leaves, the upper surface is a deeper shade of green than the lower surface. Based on the experiment (or Figure 13.16), why is that?

13.11 A scientist studies an isolated island that has no trees. It is miles and miles away from any other land mass. It is found in a region called the doldrums, where there is very little wind. However, several years later, the scientist comes back and sees trees growing. What two modes of dispersal could have gotten the tree seeds to the island?

13.12 The term “trachea” in biology refers to tubes, like the tube that carries air from your pharynx to your lungs. One group of plants you might hear mentioned are the tracheophytes. Of the four main plant categories (shown in Figure 3.21), which ones would be included in that group?

13.13 A plant makes seeds but not flowers. To which of the four main plant categories does it belong?

Chapter 13 Review Questions

1. Define the following terms:

- a. Fiber
- b. Turgor pressure
- c. Xylem
- d. Phloem
- e. Adventitious roots
- f. Transpiration
- g. Biomimicry
- h. Fruit
- i. Dichotomous key
- j. Cotyledon
- k. Deciduous

2. List the five structures you will find in a plant cell but not in an animal cell and what they do.
3. Explain why a plant wilts and what can be done to restore it to its normal state.
4. List the seven different plant cell types and the four different types of tissue found in a plant.
5. What does xylem carry and what direction does it travel? What about phloem?
6. List the four organs found in plants and describe the function of each. What type of plant has all four?
7. What is the tip of a root called? What three zones exist in a root and what happens in each?
8. List the four basic divisions of tissue in a stem. Which of those has a cambium, and what does the cambium do?

9. How is a seed like a bird's egg (or reptile's egg, for that matter)? Aside from the type of organism that emerges, what is the major difference?

10. List the four categories into which plants can be grouped and describe the characteristics that put them in that group.

11. Of the four categories of plants you listed in question 10, which contains the smallest plants? Which contains the majority of plants on earth? Which contains plants whose dominant form is the gametophyte?

12. Identify the structures in each of the diagrams below:

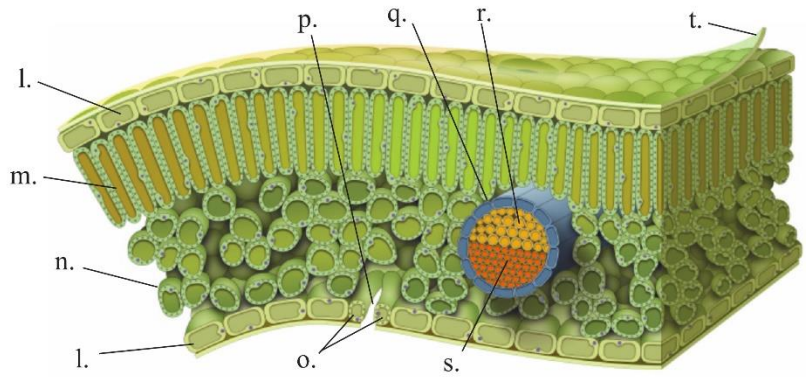
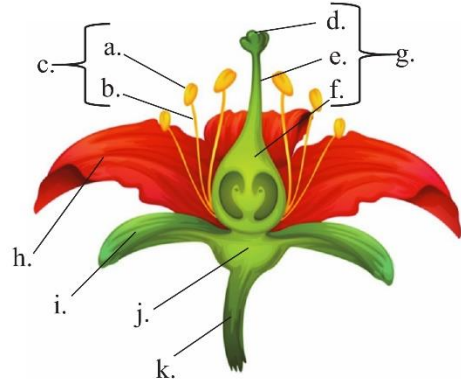

a)

k)

b)

l)

c)

m)

d)

n)

e)

o)

f)

p)

g)

q)

h)

r)

i)

s)

j)

t)

Chapter 14 Comprehension Check Questions.

- 14.1 The turgor pressure in two guard cells is high. Is the stoma open or closed?
- 14.2 In the experiment, why were you told to keep the lights on in the room?
- 14.3 The osmotic pressure in a portion of the phloem is low. Is it near a source or a sink?
- 14.4 A soil that is good for growing plants must have the right mix of bacteria in it. Why?
- 14.5 For each of the following, indicate whether it is haploid, diploid, or triploid: microspore mother cell, megaspore mother cell, tube nucleus, sperm nucleus, egg cell, zygote, first endosperm cell.
- 14.6 If the seeds of certain plants (like lettuce) are buried too deeply, they will never germinate. Why?
- 14.7 If you would like an indoor long-day plant to make flowers but don't want to spend a lot of energy on keeping the room lit most of the day, what can you do?
- 14.8 Does abscission happen in evergreen trees?
- 14.9 Mosses have low nutritional value to most herbivores, so they are usually not eaten if other plants are available. However, when it is very cold, animals like reindeer will eat mosses, even when other plants are available. Can you think of a reason why they do this?
- 14.10 Some space missions have grown plants in environments with artificial lights but essentially no gravity. What part of the plant would have more trouble growing properly: the stem or the root?

Chapter 14 Review Questions

1. Define the following terms:

- a. Physiology

- b. Pressure-flow

- c. Vegetative reproduction

- d. Pollination

- e. Germination

- f. Phytochromes

- g. Cryptochromes

- h. Photoperiodism

- i. Thermoperiodism

- j. Annual

- k. Perennial

- l. Biennial

- m. Abscission

- n. Dormancy

- o. Quiescence

- p. Senescence

- q. Apical dominance

- r. Tropism

2. List what two things are needed for the guard cells to open a stoma. Also, describe how the cell wall of a guard cell varies and indicate how the size of its central vacuole changes as the stoma opens.

3. Explain cohesion-tension transport in xylem.

4. What is the name of the process that transports materials in the phloem. Why can't cohesion-tension transport be used?

5. Is a mature leaf a source or sink for sugar in a plant? What about a root that isn't storing anything? What about a fruit that is forming? Does sugar flow towards a sink or away from a sink?

6. Name the three chemicals that nitrogen (N_2) is converted into in order for plants to be able to use nitrogen. What kind of organism does this conversion?

7. If a plant arises by vegetative reproduction, how does its genome compare to the parent plant? If a flowering plant fertilizes itself, is the result the same?

8. Indicate whether mitosis or meiosis is responsible for each of the following changes:

a. Microspore mother cell becoming microspores

b. Microspores becoming pollen grains

c. Megaspore mother cell becoming megaspores

d. Megaspore becoming an embryo sac

9. Of the eight structures listed in 8a – 8d, which is the male gametophyte of the plant and which is the female gametophyte?

10. What makes up a pollen grain? Indicate the function of each component.

11. What makes up an embryo sac?

12. Many biologists say that flowering plants do double fertilization when they sexually reproduce. Why? After this happens, what does the diploid cell develop into? What does the triploid cell develop into?

13. What are the three parts of the embryo in a seed? What is the first to emerge during germination? What does each part end up becoming in the plant?

14. As the seedling is developing underground, what is supplying it with the energy it needs?

15. What are long-day plants, short-day plants, and day-neutral plants?

16. What two ways can you get long-day plants to flower in the winter?

17. In a tree, abscission happens slowly throughout the year. Is this an evergreen or a deciduous tree?

18. If a deciduous tree is dormant, does it have its leaves?

19. What are plant hormones sometimes called to emphasize that they are different from animal hormones?

20. Which category of plant hormone is really important in apical dominance?
21. If a plant is unusually small for its species, which category of plant hormone is probably not being made?
22. Which category of plant hormone is important in the process of a flower starting to form an immature fruit?
23. Which two plant hormones categories are important in abscission? Which of those two also ripens fruit?
24. Which tropism describes each of the following plant behaviors?
- a. Sunflowers turning to follow the sun as it moves in the sky
 - b. Ivy clinging to a brick wall
 - c. Roots in a potted plant growing down no matter how the pot is oriented

Chapter 15 Comprehension Check Questions

15.1 In a particular ecosystem, a disease wipes out many of the secondary consumers. What will happen to the number of organisms in the other trophic levels?

15.2 A water molecule percolates into the soil but rather than going into the flow of groundwater, it ends up in a cloud. What happened after it entered the soil?

15.3 The amount of carbon dioxide in the atmosphere has been increasing since about 1850 and shows no indication of getting lower any time soon. What is the most likely reason for this?

15.4 An area gets an unusually large amount of lightning over a period of a few days. All other things being equal, should the population of denitrifying bacteria increase, decrease, or stay the same?

15.5 If a warm-blooded animal has very little fat and a thin coat of fur, in what kind of climate does it live?

15.6 Soil in a given area is composed mostly of silt and clay. If there is a hard rain, compare how long that soil will hold the water to how a healthy loam would hold the water.

15.7 While we usually think of biodiversity in terms of nature, there is biodiversity in you. What is it, and what kinds of direct value does it have for you?

15.8 Without doing any searching in books or on the internet, do you think there is more air pollution today compared to 40 years ago?

15.9 When one of us (JLW) traveled to New Zealand, a dog led customs officers to his wife because of something it smelled in her carry-on bag. Customs agents weren't using the dog to detect drugs. What were they using it to detect?

1. Sustainability

m. Renewable resource

n. Climate change

2. A tertiary consumer must use all the energy contained in 1 kg of food. How many kg of secondary consumers must exist to support it? How many kg of primary consumers? How many kg of producers?

3. A molecule of water starts in the ocean. Using the terms percolation, evaporation, precipitation, condensation, and transpiration, describe what had to happen for that molecule to end up:

a. in groundwater

b. back in the atmosphere after being in a plant

c. in run-off

4. For each of the following, indicate whether it adds carbon dioxide to the atmosphere or removes it:

a. Cellular respiration

b. Photosynthesis

c. Decomposition

d. Burning fossil fuels

e. Carbon dioxide dissolving in water

5. What organisms and processes perform nitrogen fixation? Which take fixed nitrogen and put it back into the atmosphere? Where do consumers get the nitrogen they use? How do they put it back in the soil?

6. Where does the phosphorus in the phosphorus cycle originate? What cycle helps to move it around?

7. How do farmers affect the nitrogen and phosphorus cycles?

8. In an area of high humidity, how much rain do you expect compared to an area of low humidity?

9. From which general direction do the trade winds originate? In which general direction do they blow? What about the westerlies? Which are closer to the equator?

10. Order the three particles that make up a loam in terms of increasing size.

11. What are the three components of biodiversity conservation?

12. What are the five drivers of change that we discussed in reference to biodiversity conservation?

13. What is coral bleaching?

14. Give an example of a species that is extinct due to exploitation.

15. Give an example of an invasive species that has caused harm to the environment.

16. List and describe the five types of renewable energy that we discussed.

17. What are the problems associated with wind power? What about solar power? What about hydropower?

18. Much is made of the fact that the 10 hottest years on record (according to the thermometer data we have) were all within the last 15 years (as of 2020). Why is this neither surprising nor unusual considering the earth's long-term history?

19. What was the Little Ice Age?

Chapter 16 Comprehension Check Questions

16.1 When you studied bacteria, you learned that they sometimes form colonies. What kind of interaction would that be?

16.2 Why isn't the formation of a bacterial colony an example of mutualism, since all the bacteria benefit?

16.3 When pioneer species move into an area as a result of primary succession, what kind of population growth will they most likely experience: exponential or logistic? What will cause that to change?

16.4 While epiphytes are common in tropical rainforests, there are also parasitic plants that harm the trees they grow on. If you see a plant growing on a tree, what could you look for to determine whether it is an epiphyte or a parasite?

16.5 If you were to start at the equator and then travel north staying on land, would you initially see more deserts or temperate forests? How would that change as you continued to move north?

16.6 A plant has thin leaves and stems that do not store water. Of the three biomes you have learned so far, in which does it probably *not* live?

16.7 If you see a picture of a grasslands scene, and the ground is covered with flowers, is the grassland most likely in Africa or Russia?

16.8 Suppose you see a picture of a cougar and another picture of a snowshoe hare. Which biome would you guess each picture was taken in? For which picture can you be more certain?

16.9 Suppose you find caribou moss growing in a forest. What kind of forest will it probably be?

16.10 Suppose you measure the salinity of the waters in an estuary. How will the salinity change based on the water's location?

16.11 Why is the salinity of the epipelagic zone of the ocean so high? HINT: Think about the water cycle.

Chapter 16 Review Questions

1. Define the following terms:

a. Population growth

b. Ecological succession

c. Habitat

d. Biome

e. Ecosystem

f. Biosphere

g. Epiphyte

h. Grasses

i. Permafrost

j. Estuary

k. Salinity

l. Bioluminescence

2. Label each of the following as independence, cooperation, or competition within a species.
 - a. Two males fight over territory.

 - b. A platypus lives in a pond that has no other individuals from its species.

 - c. Dolphins surrounding a female dolphin while she is giving birth.

3. Label each of the following as mutualism, commensalism, or parasitism.
 - a. A plant forces its roots into another plant, pulling nutrients from the other plant.

 - b. A jackal follows a tiger, picking up pieces of prey that the tiger leaves behind.

 - c. Ants protect aphids, making sure they get plenty to eat so that the ants can drink the sweet liquid that the aphids make after eating.

4. Predators and prey have a relationship, but it is generally not considered symbiotic. Why?

5. An elephant dies, and the population of decomposers that inhabits its remains are studied. How would you describe the population growth at first? Will that change? If so, how and when?

6. You are looking at two plants. One is short and grows quickly. The other is tall and grows slowly. Which is most likely a pioneer species?

7. What is the difference between primary and secondary succession?

For questions 8-16, use the following answers: scrubland, temperate forest, tundra, rainforest, desert, grassland, coniferous forest

8. Which of the biomes listed above would be found closest to the poles? Which would be closest to the equator?

9. Which would be closer to the equator: scrublands or coniferous forests?

10. Which of the biomes listed above has the greatest diversity of life?

11. Which of the biomes listed above is characterized by very low amounts of precipitation?

12. In which of the biomes listed above would you find the most evergreens?

13. In which of the biomes listed above will you find the most epiphytes?

14. Which of the biomes listed above is dominated by short plants that have hollow stems and narrow, blade-shaped leaves?

15. In which of the biomes listed above would you find clumps of shrubs with barren areas in between?

16. In which of the biomes listed above would you find permafrost?

17. List the zones of a rainforest, starting with the lowest and ending with the highest.

18. List the zones of a temperate forest, starting with the lowest and ending with the highest.

19. What is stored in a camel's hump?
20. What are the two kinds of coniferous forests? What is the main difference between them?
21. If a grassland is not temperate, what is it called?
22. Describe the zones of a lake.
23. What is aerenchyma, and what must an aquatic plant do if it doesn't have that tissue?
24. If an aquatic ecosystem's salinity varies greatly based on the location but not depth, what kind of ecosystem is it?
25. List the zones of the ocean in terms of increasing depth. Also, what is the benthic zone?
26. What two provinces make up the pelagic division of the ocean, and which is closer to shore?
27. In which zones of the ocean do you find bioluminescent organisms?
28. Some animals are called benthic animals. Where do they live?

Documenting Experiments

The problem with learning things is that you can forget them pretty easily. As a result, it is important to document what you learn. That way, you can always go back later and review the material. When it comes to documenting what you learned by taking this course, you answer questions and take tests. How do you document what you learned in an experiment? By recording important aspects of the experiment in your laboratory notebook.

Start your record by writing the number and title of the experiment. Then write “Data:” underneath the title. That’s how you should start to document every lab you do. You should write the experiment number and its title. Underneath, you should write “Data:” to indicate that what follows will be all the data you collect from the experiment.

What are the data you collect in an experiment? Those are your *observations*. Every experiment has data, because every experiment requires you to make observations as the experiment progresses. So under “Data:” you should list every observation you make. Each new observation should be written underneath the previously-made observation. Some experiments require more than just observations. Some require measurements. If the experiment instructions tell you to measure how long something is, that measurement is also considered data and should be written down along with your observations.

Each piece of data needs to have a short explanation regarding when you collected it in the experiment. That allows you to remember what you did right before you made the observation. It doesn’t need to be a long explanation. It just needs to be a short note that will help remind you of what was done right before the observation was made.

The data section of each lab report, then, contains the quick notes you make while you are doing the experiment. They help remind you what you saw at each important step in the experiment. You write these things down while you are doing the lab so that they are fresh in your mind.

But that’s not all you need to do to document your lab. So far, I have discussed things you write down *while you are doing the lab*. Once the lab is over, you need to finish documenting it. How do you do that? You add another section to your lab report that is labeled “Summary:”. In that section of the lab, you write your own summary of what you did. It should not be a step-by-step listing of the instructions, and it *cannot* be a copy of the lab instructions that are in the book. Instead, it needs to be your “story” about what you did in the experiment.

Once you have finished your summary, there is one more section you need to add. Label this section “Conclusions:”, and it should contain a discussion of what you were supposed to learn by doing the experiment. This is actually easy, because I always explain that after the experiment. So all you have to do is give that same explanation, but in your own words. Once you’ve done that, you are finished documenting your lab.

While this might seem like a lot of work, it's important for three reasons. First, it gives you something you can review later so that you can remember what you learned. Second, when you write something out in your own words, you think through it. As a result, you learn it better. Finally, there are times where you have to actually show evidence that you did experiments. Most universities, for example, require that students do experiments as a part of their high-school science courses. If you apply to a university, the people who decide whether or not you can come to the university might ask you to demonstrate that you did experiments. A lab notebook is exactly what they are looking for.

Now remember, the main goal for doing this is so that you can go back and review it later to recall what you did, what you saw, and what you learned. However, it is also possible that you will need to use this report to give evidence that you did laboratory work in your science course. Since that's one of the goals, you need to write your report so that someone who has never seen the book can understand what you did and what you learned. Obviously, just reading the data section will be confusing to someone who doesn't have access to the instructions, but that's why you add a summary after the data. It helps someone who has not read the book to understand what you did, what you saw, and what you learned.

Now please understand that there is no standard among science courses regarding how you should document your labs. Some high school science courses require you to write at least a few of your experiments the way you would write about them in a scientific journal. This is usually called a "formal laboratory report."

I don't think students in middle school and high school should do those kinds of reports. First, most students who take science will never actually write such a report in real life. As a result, it seems like a waste of time for most students. More importantly, the way you write a formal lab report changes depending on the kind of science you are doing. As a nuclear chemist, for example, the papers that I have published in the scientific literature follow a completely different format than the papers my wife (a biophysicist) has published in the scientific literature. In my opinion, you should determine what kind of science you will be doing before you start worrying about writing a formal laboratory report.

Other science courses want you to follow the scientific method when you document your lab work. They want you to start your report with a hypothesis and end your report with a conclusion about whether or not your hypothesis was confirmed. I don't see that as reasonable for most situations involving students. After all, that's not what you are doing. You aren't making or testing a hypothesis. You are simply following my instructions. Also, when you make a hypothesis, you should design your experiment to address the hypothesis. Making a hypothesis for an already-designed experiment is backwards when it comes to the scientific method.

If you follow my method for documenting your labs, you will practice the most important aspect of laboratory work: making a record of what you did, what you saw, and what you learned. No matter what kind of science you end up doing, you will have to do that. Thus, by getting experience documenting labs in this way, you will be honing a skill that you will use if you pursue any kind of science.

This is important, since a scientist's laboratory notebook can become a legal document. If you discover something new and need to demonstrate that you were the one who discovered it, you can do that with your laboratory notebook. In addition, if someone disputes what you have concluded based on your experiments, your laboratory notebook can be used to resolve that dispute. In the end, then, getting used to properly documenting your experiments is an important part of science education.

Laboratory Notebook

